



NANYANG PRIMARY SCHOOL
FIRST SEMESTRAL EXAMINATION
2007

PRIMARY 2
MATHEMATICS

DURATION: 1 HOUR 30 MINUTES

Section A	/ 40
Section B	/ 40
Section C	/ 20

Total:	/ 100
---------------	--------------

Name: _____)

Class: Primary 2 (_____)

Date: 10 May 2007

Parent's Signature: _____

DO NOT OPEN THIS BOOKLET UNTIL YOU ARE TOLD TO DO SO.

FOLLOW ALL INSTRUCTIONS CAREFULLY.

ANSWER ALL QUESTIONS.

Section A

Questions 1 to 20 carry 2 marks each.

For each question, four options are given.

One of them is the correct answer.

Choose the correct answer and write its number (1, 2, 3 or 4) in the brackets () provided. (Total:40 marks)

1. The number just before 500 is _____.

(1) 400

(2) 499

(3) 501

(4) 600

()

2. 820 is the same as _____ tens.

(1) 20

(2) 2

(3) 82

(4) 820

()

3. The sum of 430 and 12 is _____.

(1) 310

(2) 418

(3) 442

(4) 550

()

4. 10 more than 291 is _____.

(1) 191

(2) 281

(3) 301

(4) 391

()

5. What is the missing digit in the box?

$$\begin{array}{r} 672 \\ - 411 \\ \hline 2\boxed{?}1 \end{array}$$

- (1) 8
(3) 3

- (2) 2
(4) 6

()

6. Jane had 123 marbles. Her father gave her 210 marbles and her mother gave her 135 marbles. How many marbles did Jane have in all?

- (1) 333
(3) 468

- (2) 345
(4) 568

()

7. Mrs Tan made 384 apple tarts on Monday. She made 277 fewer apple tarts on Monday than on Tuesday. How many apple tarts did Mrs Tan make on Tuesday?

- (1) 107
(3) 551

- (2) 113
(4) 661

()

8. There are 532 books in the library. 196 of the books are Chinese books and the rest are English books. How many English books are there in the library?

(1) 336
(3) 436

(2) 344
(4) 446

()

9. Study the pattern below.
What is the missing number in the box?

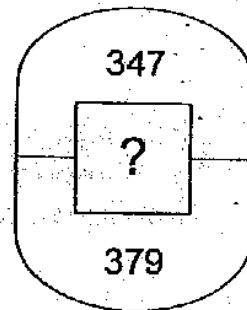
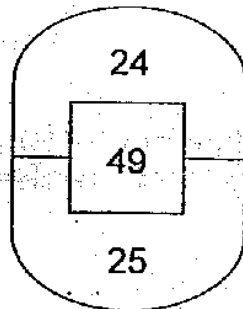
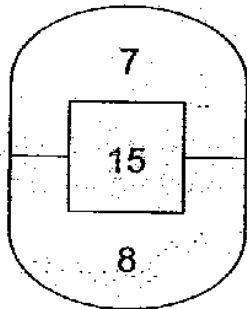

(1) 347
(3) 626

(2) 616
(4) 726

()

10. There were 489 oranges. Mrs Lee sold 132 of them on Friday. She then sold another 144 oranges on Saturday. How many oranges were left?

(1) 213
(3) 357

(2) 293
(4) 413

()

11. The length of my classroom is about _____ metres.

(1) 9

(2) 90

(3) 900

(4) 9000

()

12. How much taller is the tree than the giraffe?

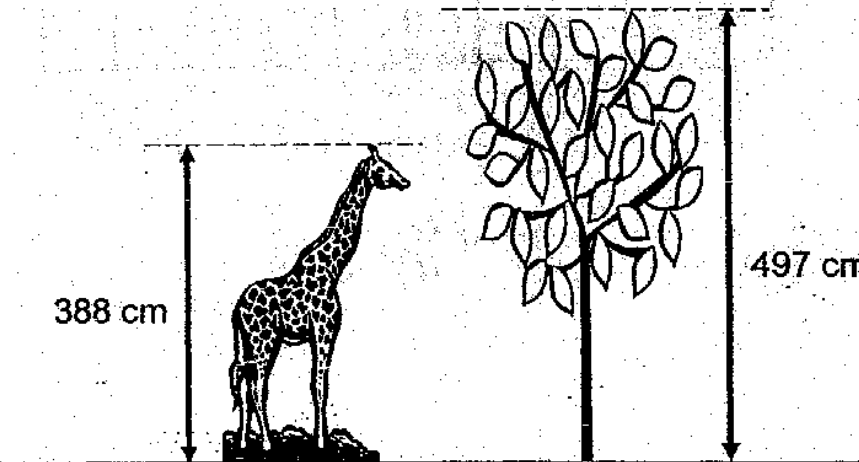

(1) 101 cm

(2) 109 cm

(3) 785 cm

(4) 885 cm

()

13. Study the pattern below. What is the missing number?



(1) 0

(2) 6

(3) 3

(4) 4

()

14. The pair of scissors is _____ cm longer than the pencil.

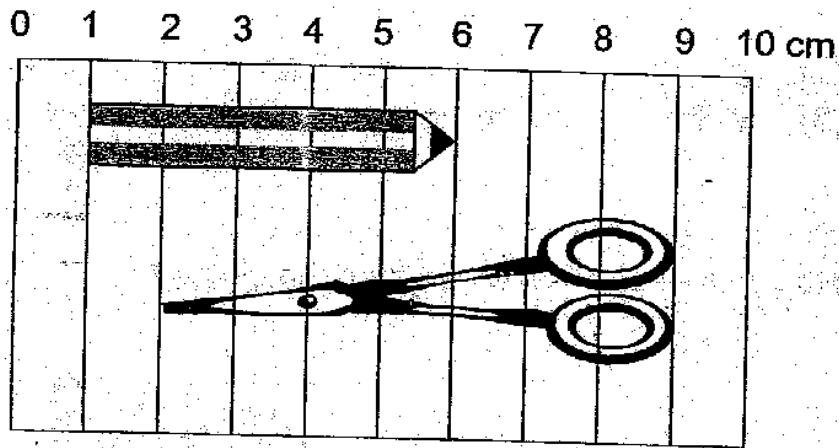

- (1) 1
- (3) 3

- (2) 2
- (4) 4

(. .)

15. The length of the television set is 105 cm. Its width is 32 cm shorter than its length. What is the width of the television set?

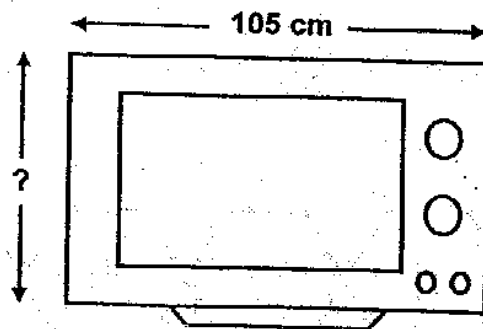

- (1) 73
- (3) 137

- (2) 77
- (4) 173

(. .)

16. The mass of the kettle is about _____ g.

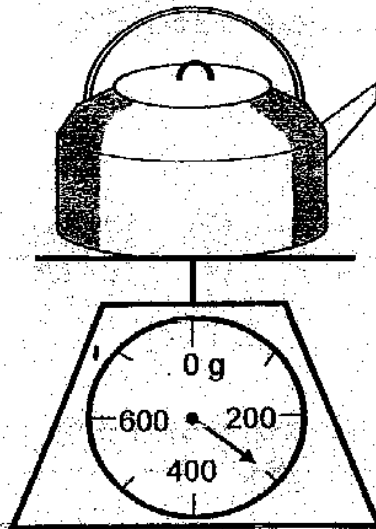

- (1) 100
- (3) 300

- (2) 200
- (4) 400

()

17. Arrange the objects P, Q and R from the lightest to the heaviest.

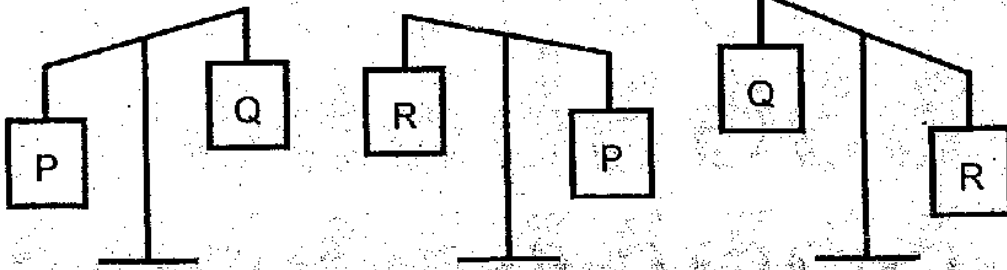

- (1) Q, R, P
- (3) R, P, Q

- (2) P, R, Q
- (4) Q, P, R

()

18. There was 278 kg of sugar in Mr Ho's shop. He packed it into 3 sacks. If there was 89 kg in sack A and 97 kg in sack B, how much sugar was there in sack C?

(1) 92 kg
(3) 112 kg

(2) 102 kg
(4) 192 kg

()

19. What is the missing number in the box?

$$5 \times 2 = 4 + \boxed{?}$$

(1) 6
(3) 3

(2) 10
(4) 14

()

20. Put 30 apples into bags of 5. There are _____ bags of apples.

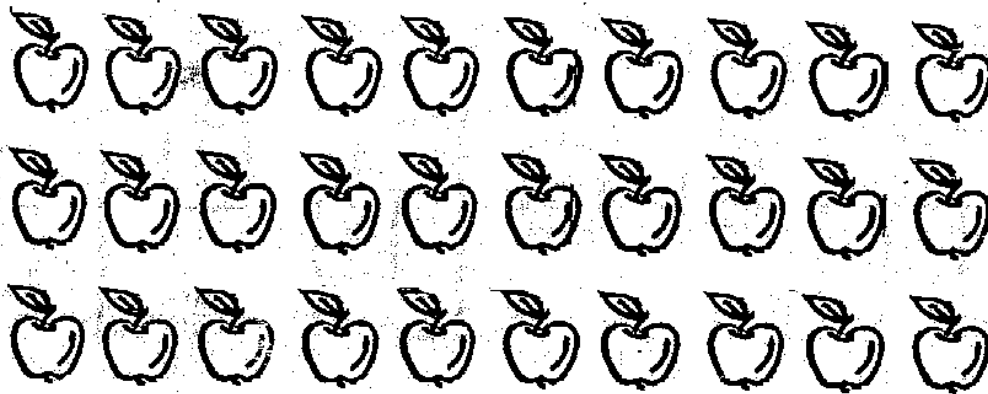

(1) 5
(3) 6

(2) 7
(4) 8

()

Section B

Questions 21 to 40 carry 2 marks each.

Write your answers in the spaces provided.

Give your answer in the units stated.

(Total: 40 marks)

21. Write 612 in words.

22. In 378, there are _____ hundreds and _____ ones.

23. Using the digits given below, form the smallest 3-digit number. Each digit may be used only once.

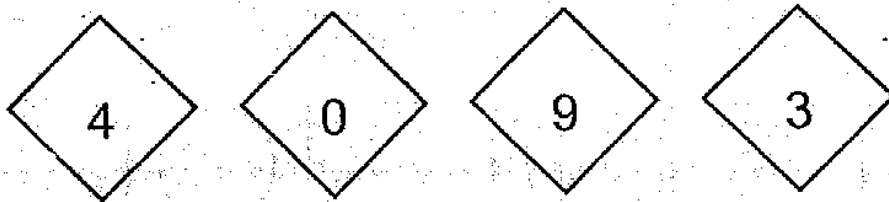

Answer : _____

24. Arrange the numbers in order. Begin with the greatest.

676, 776, 667

25. Study the number bond below carefully.
Write two subtraction sentences based on the number bond.

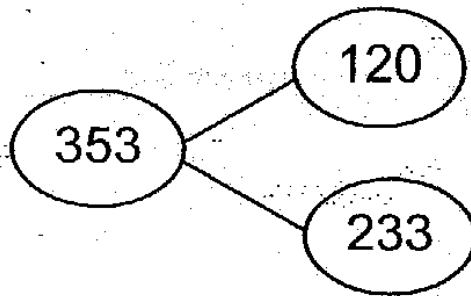

(a)

(b)

26. Fill in the missing digits in the boxes.

$$\begin{array}{r} 321 \\ + 1\boxed{ }5 \\ \hline \boxed{ }06 \\ \hline \end{array}$$

For Questions 27 and 28, refer to the diagram below.

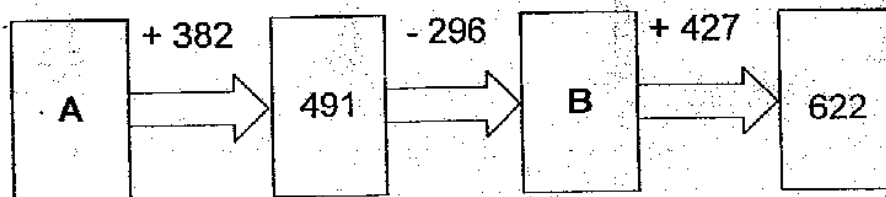

27. What is the number in Box A?

Answer : _____

28. What is the number in Box B?

Answer : _____

29. Mr Gopal had 696 fishes in his aquarium. He sold 224 fishes and bought another 332 fishes. How many fishes did he have in the end?

Answer : _____

30. Each lamp post is 250 cm away from the next lamp post. How far is the first lamp post from the last lamp post?

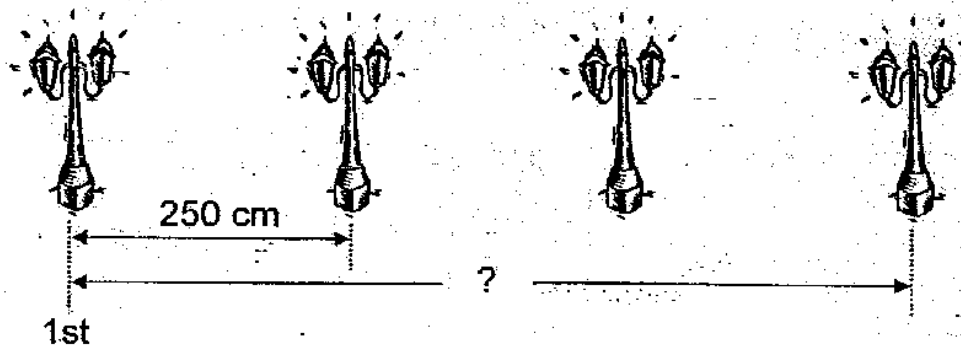

Answer : _____ cm

31. Shuyi used a piece of wire to form the triangle below. If she wanted to make another identical triangle, how much wire would she need to form both triangles?

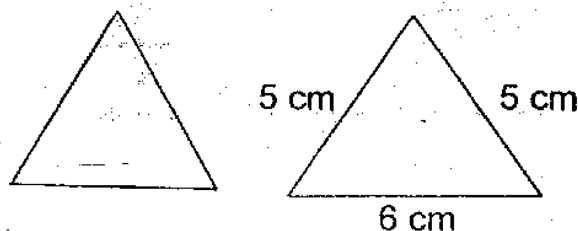

Answer : _____ cm

32. Old Macdonald delivered milk from House A to House B, then to House C as shown in the diagram below. He walked a total distance of 960 m. What is the distance between House A and House B?

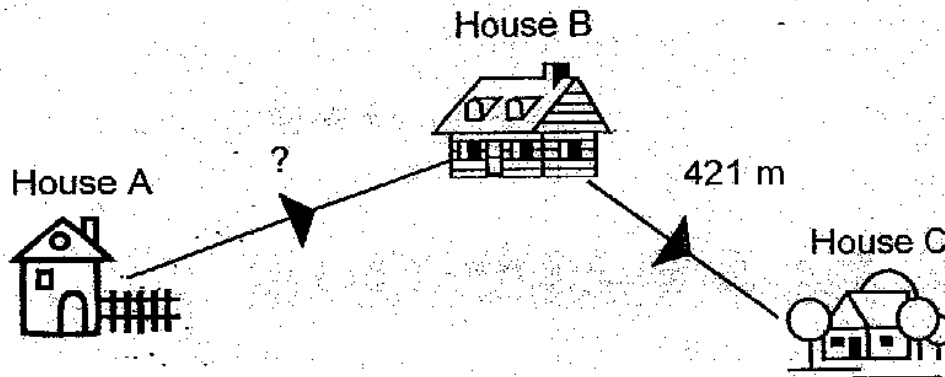

Answer : _____ m

33. Find the total mass of the heaviest child and the lightest child.

Name of child	Mass (kg)
Huiling	42
Ismail	57
Jun Kai	39
Keith	40

Answer : _____ kg

34. Mother needs 532 g of flour to bake some muffins. She has 276 g of flour. How much more flour does she need?

Answer : _____ g

35. What is the missing number in the box?

$$27 \div 3 = 3 \times \boxed{?}$$

Answer : _____

36. Ring the stars to show 8 groups of 3 and write a multiplication sentence.

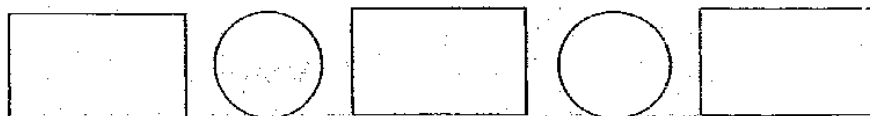
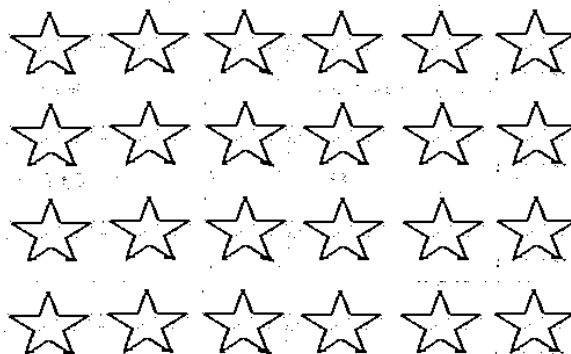

37. Using the cards below, write a multiplication sentence and a division sentence. You may use each card more than once.

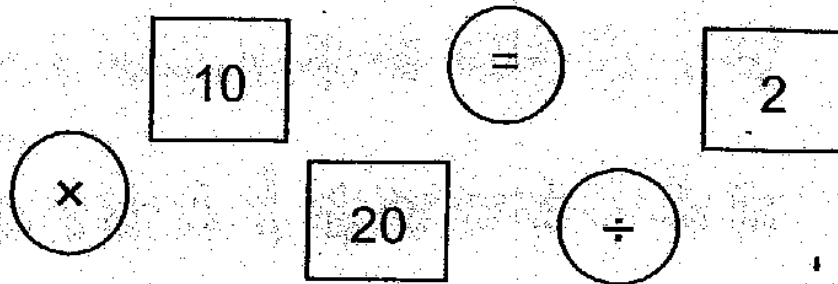

38. There were 9 children at a birthday party. Each child was given 2 balloons. If 3 of the balloons burst, how many balloons were left?

Answer : _____

39. A florist has 36 flowers. If she puts 4 flowers in each vase, how many vases does she need?

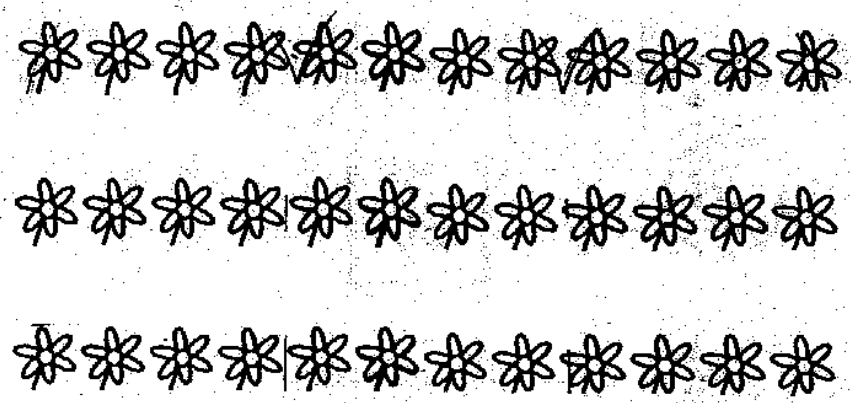

Answer : _____

40. Meiling, Siti, David, Ahmad and Steve are going to play a game. A team can only be made up of a boy and a girl. In how many ways can a team be formed?

Girls



Meiling



Siti

Boys



David



Ahmad



Steve

Answer : _____

Section C

Questions 41 to 45 carry 4 marks each.

Do these word problems carefully.

Show your working clearly in the space provided for each question.

(Total: 20 marks)

41. Andrea has \$108 in her piggy bank. Bala has \$265 in his piggy bank.

(a) Label the model below by filling in the blanks.

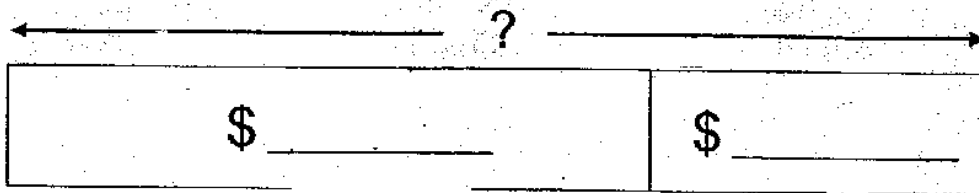

(b) How much money do Andrea and Bala have altogether?

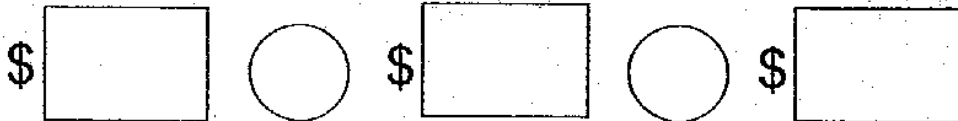

They have \$ _____ altogether.

42. There were 968 people at a funfair. 313 of them were adults and the rest were children.

(a) How many children were there?

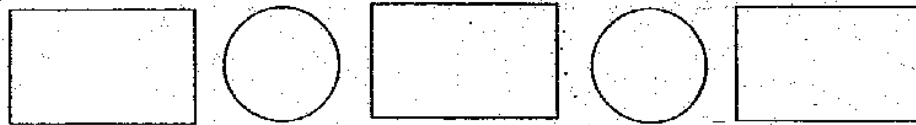

There were _____ children.

(b) How many more children than adults were there?



There were _____ more children than adults.

43. Weiming has 30 fish balls altogether. He puts 3 fish balls on every stick. Then he gives the sticks of fish balls equally to 2 children. How many sticks of fish balls will each child get?

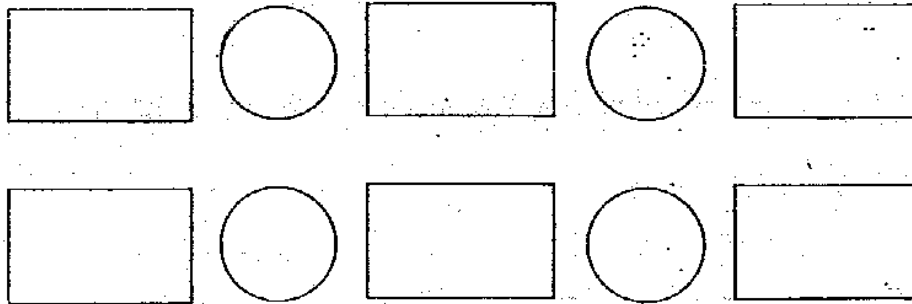
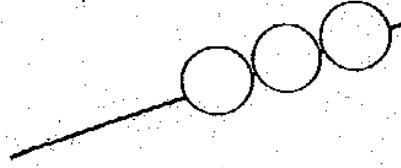

Each child will get _____ sticks of fish balls.

44. Look at the diagram below.

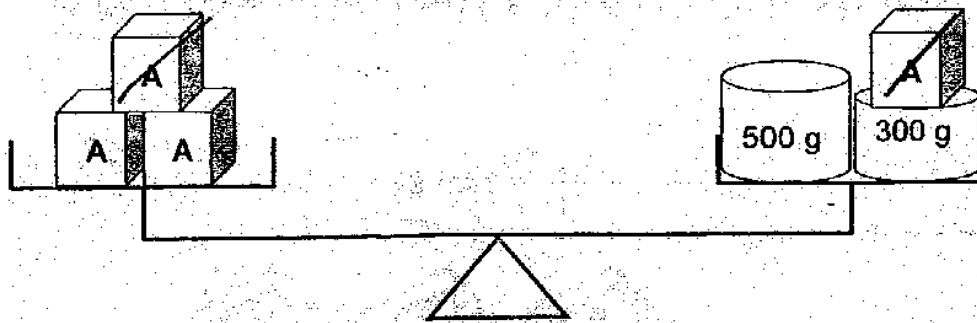

(a) The mass of Cube A is _____ g.

(b) Cube B is 175 g lighter than Cube A. What is the mass of Cube B?

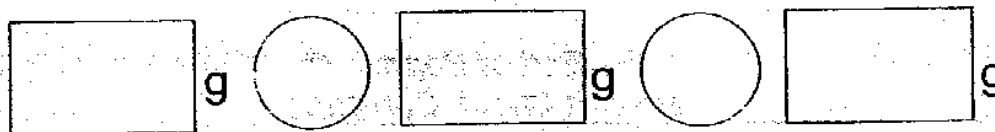
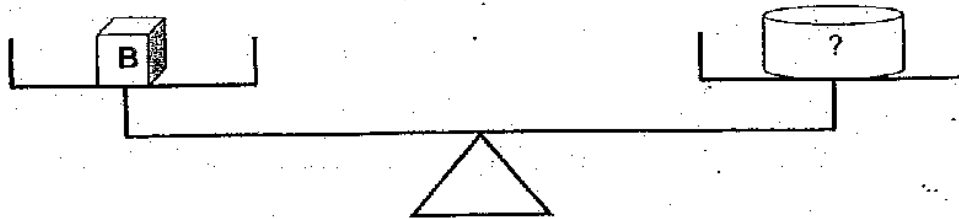

The mass of Cube B is _____ g.

45. 3 pairs of shorts cost \$10. Mrs Low bought some shorts and paid \$60 for them. How many pairs of shorts did she buy?

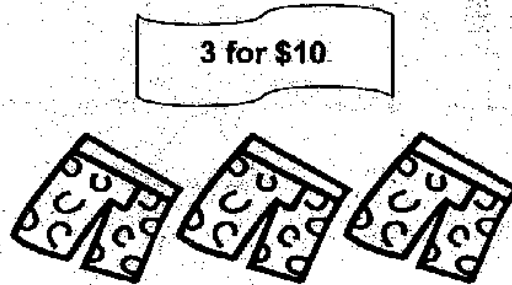

Pairs of shorts	
Cost (\$)	

Mrs Low bought _____ pairs of shorts.

☺ End of Paper ☺
Please Check Carefully

Setters: Mdm Serene Leong
Mdm Yee Ming Ming

ANSWER SHEET

NANYANG PRIMARY SCHOOL - PRIMARY 2 MATHEMATICS 2007
SEMESTRAL ASSESSMENT (1)

1.2

2.3

3.3

4.3

5.4

6.3

7.4

8.1

9.4

10.1

11.1

12.2

13.4

14.2

15.1

16.3

17.1

18.1

19.1

20.3

21. Six hundred and twelve

22. 3 hundreds and 78 ones

23. 304

24. 776, 676, 667

25. a) $353 - 233 = 120$

b) $353 - 120 = 233$

26.
$$\begin{array}{r} 321 \\ + 185 \\ \hline 506 \end{array}$$

27. 109

28. 195

29. $696 - 224 + 332 = 804$

30. 750

31. 32

32. $960 - 421 = 539$

33. $39 + 57 = 96$

34. $532 - 276 = 256$

35. 3

36. $8 \times 3 = 24$

37. $2 \times 10 = 20$

$20 \div 2 = 10$

38. $9 \times 2 = 18$

$18 - 3 = 15$

15 ballons left

39. $36 \div 4 = 9$

40. $3 \times 2 = 6$

41. a)

\$265	\$108
-------	-------

Bala Andrea

b) $\$265 + \$108 = \$373$

They have \$373 altogether

42. a) $968 - 313 = 655$

There were 655 children

b) $655 - 313 = 342$

There were 342 more children than adults

43. $30 \div 3 = 10$

$10 \div 2 = 5$

Each child will get 5 sticks of fish balls.

44. a) 400g

b) $400\text{g} - 175\text{g} = 225\text{g}$

The mass of cube B is 225g.

45.

Pairs of shorts	3	6	9	12	15	18
Cost (\$)	\$10	\$20	\$30	\$40	\$50	\$60

Mrs Low bought 18 pairs of shorts.